

NEW FRONT WASHER EXTRACTORS



NEW FRONT WASHER EXTRACTORS

INDEX

- 1.- Product Range - Overview
- 2.- Classification
- 3.- Main Features
- 4.- Accessories and Options
- 5.- Technical data
- 6.- Sales arguments and marketing tools

1. PRODUCT RANGE - OVERVIEW

High spin speed (G Force 350 – 450)

Control	Heating	Capacities							
		10-11 kg	13-14 kg	18-20 kg	25-28 kg	35-38 kg ^{New}	40-45 kg ^{New}	60-65 kg	120-133 kg
Microprocessor Easy Touch	Electric, hot water, steam	WED-11	WED-14	WED-18	WED-27	WED-36	WED-45	WED-60	WED-120
Easy Touch self-service	Electric, hot water	WED-11 Self	WED-14 self	WED-18 self	WED-27 self	WED-36 self	-	-	-

Fast spin speed (G Force 200)

Control	Heating	Capacities			
		10-11 kg	13-14 kg	18-20 kg	25-28 kg
Microprocessor Easy Touch	Electric, hot water, steam	WEM -11	WEM-14	WEM-18	WEM-27
Easy Touch self-service	Electric and hot water	WEM-11 SELF	WEM-14 SELF	WEM-18 SELF	WEM-27 SELF

Normal spin speed (G Force 100)

Control	Heating	Capacities					
		10-11 kg	13-14 kg	18-20 kg	25-28 kg	35-38 kg	60-66 kg
Microprocessor Easy Touch	Electric, hot water, steam	WEN-11	WEN-14	WEN-18	WEN-27	WEN-36	WEN-60
Easy Touch self-service	Electric and hot water	WEN-11 SELF	WEN-14 SELF	WEN-18 SELF	WEN-27 SELF	WEN-36 SELF	-

1. PRODUCT RANGE - OVERVIEW

HIGH SPIN RANGE – “WED” Range

- **Soft mounted** washers, free standing.
- **High G-factor: 450**
- **R.P.M. between 760 – 1245**
- **Easy to install**, no needs of fixation to the floor, no extra costs.
- **Savings** due to high extraction of water
(40-45% residual humidity).



FAST SPIN RANGE – “WEM” Range

- **Hard mounted** washers.
- *Anchoring to floor with anchoring base.*
- **High G-factor: 200**
- **R.P.M. between 700 -820**
- **Savings** due to high extraction of water
(60-70% residual humidity).

NORMAL SPIN RANGE – “WEN” Range

- **Hard mounted** washers.
- *Anchoring to floor with anchoring base.*
- **G-factor: 100**
- **R.P.M. between 538 -458**
- **Residual humidity: 70-100%**



ONE WASHER - 2 POSSIBLE USES ANYTIME

ON PREMISE LAUNDRY

SELF-SERVICE LAUNDRY



1. PRODUCT RANGE - OVERVIEW

Similar aesthetic for all the range of washers (2 Front panels)



2. CLASSIFICATION

Heating:

- Electric [E] – Heating elements.
- Hot water [HW] – Hot water inlet, reduced operating cost if hot water is available.
- Steam [S] – By means of steam injectors, lower operating cost, investment in boiler required if not available

Size models WED: 11,14 ,18 ,25 ,35, 45, 60 and 120 Kg.

Size models WEM: 11, 14, 18 and 25 Kg.

Size models WEN: 11, 14, 18, 25, 35 and 60 Kg.

Self-service: E and HW versions 11, 14, 18 and 25 kg (Tokens, coins and central pay)

Control: ET – **EASY TOUCH** Control (OPL and Self-service) .



3. MAIN FEATURES

3.1.- MANUFACTURED IN STAINLESS STEEL BODY, OUTER DRUM AND INNER DRUM

- Elegant look
- Increased resistance to the external agents
- Avoid corrosion problems
- increasing the washer lifetime
- Better quality



3.2.- DRUM REMOVABLE FROM THE FRONT (MODELS 11 ,14 ,18, 25 AND 35 KG)

- Easy-to-access mechanical parts
- Easy to extract the drum

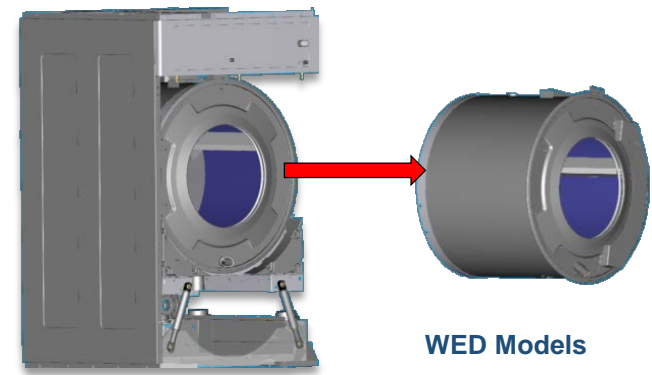
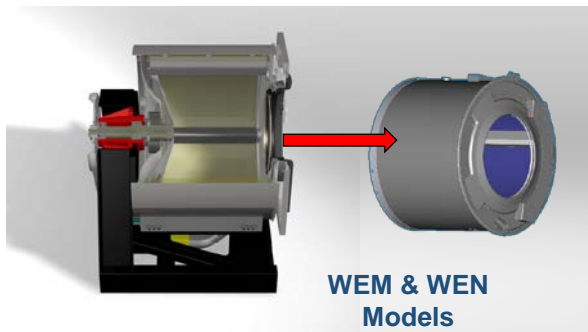

3. MAIN FEATURES

3.3. - AUTOMATIC WATER MIXER (MIXING DIFFERENT WATER TEMPERATURES)

- Energy savings
- Reduced Washing Time

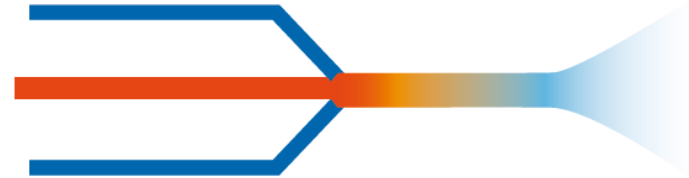

3.4.- SOAP DOSING SYSTEM

- New water ducts, as well as easy detergent connection. Complies with the WRAS certification
- Detergent dispenser drawer with 4 sections (5 for WED 45 to 120 kg.)
- Rear connections for automatic liquid dosing. Up to 8 dosing signals (Option 6 extra signals)



Detergent dispenser
as from 45 kg model



3. MAIN FEATURES

3.5.- IMBALANCE SYSTEM

- Thanks to an advanced technological development, and by means of the inverter, the washers detect the imbalance at an early stage
- Operation is much smoother, making components long lasting
- Reduced Washing Time
- Energy savings

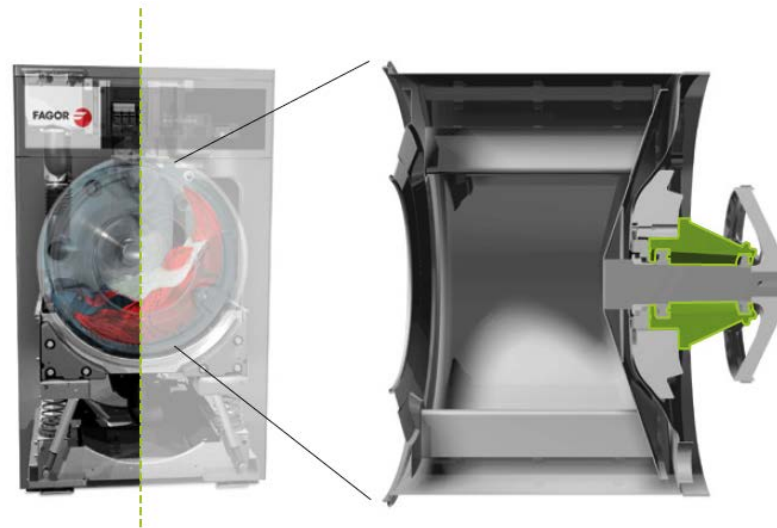

3. MAIN FEATURES

3.6.- WET CLEANING

All washers have the necessary features to use the WET CLEANING system.

- Full control of temperatures and levels of water.
- Washing speed of 15 RPM.
- Rhythm on/off of 1sec/1sec
- Manual control of each dosing signals



Wet cleaning

3.7.- TOP QUALITY AND REPUTED BRANDS

- Ball bearings: NSK
- Radial Seals from 11 to 35 kg. washer: V-RING seals (external Viton)
- Radial Seals from 45 to 120 kg. washer: V-RING seals (Viton)
- Inverter: Delta / KEB (WED 45, 60 and 120)
- Contactors: Siemens / ABB

3. MAIN FEATURES

3.8.- TECHNICAL MENU

Complete technical menus

- Failure self-diagnosis systems (Auto-test)
- Alarms
- Saving of information (cycles, time working, spinning, alarms, etc...)
- Restricted access areas

Ergonomic access to control panel parts- Hinged panels



3.9.- 3RD WATER INLET AS STANDARD

All washers are equipped with a third water inlet, used for soft water (Save filling time), ozone or recycled water (energy and water savings`

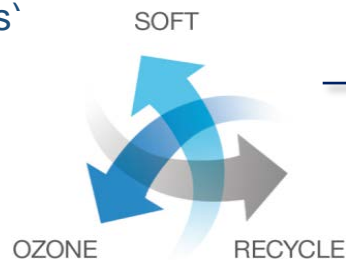

3. MAIN FEATURES

3.10.- SMALL PERFORATIONS IN THE RIBS OF THE DRUM

Water has a cascade effect on the load

- Maximizes the washing quality with the shortest cycle time possible
- Increases considerably the mechanical action inside the drum
- Reduces the need of water

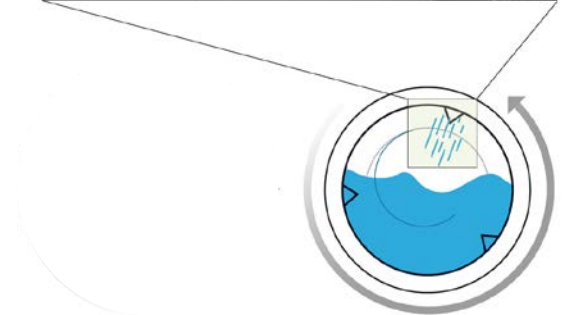

3.11.- DRUM AND TUB'S EFFICIENT DESIGN

A narrow gap between them, as well as the overuse of chemicals and water

- Reduces the energetic consumption to heat up the water
- Increases considerably mechanical action inside the drum

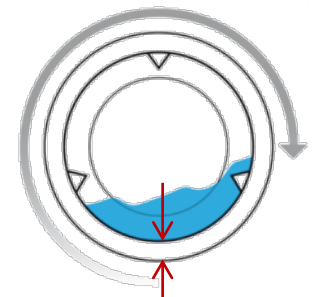

3. MAIN FEATURES

3.12.- OPTIMAL CONSUMPTION

Efficient system by means of which you can indicate the load which is introduced in the machine. The washer, automatically, adapts the quantity of water and chemicals to be used for this load.

- Reduces operation costs
- Savings



3.13.- VOLTAGE

- Models 11,14,18, 25 and 35 Kg. Single-phase *(except 25 and 35 kg electric models)*
- All washers are 50/60 Hz

3.14.- DIMENSIONS

Dimensions for High spin WED models

- 11 kg washers extractors with dimensions narrower than 700 mm
- 14 kg washers extractors with dimensions narrower than 800 mm

Dimensions for fast spin WEM models & normal spin WEN models

- 11, 14 and 18 kg. washers extractors with dimensions narrower than 800 mm
- 25 kg washers extractors with dimensions narrower than 900 mm

3.15.- DOOR LOCK SAFETY

3. MAIN FEATURES

3.16.- CERTIFICATS ET HOMOLOGATIONS

- WRAS approvals (UK).
- ETL (USA and Canada) for WEN-11 to 60, WEM-11 to 25, WED-11 to 35
- CE.



3. MAIN FEATURES - EASY TOUCH

ON PREMISE LAUNDRY



SELF-SERVICE LAUNDRY



3. MAIN FEATURES - **EASY TOUCH**

FEATURES

- **Touch Screen 4.3"**.
- Programmer: **33 available languages**.
- **USB port** for washer's software updates and other applications.
- **Same EASY TOUCH Control** for **OPL** washers and **coin** washers.

3. MAIN FEATURES - **EASY TOUCH**

PROGRAMMING

- **User-friendly** and **intuitive** programming.
- **26 factory pre-set programs.**
 - 4 Intensive
 - 3 Standard
 - 4 Economic
 - 3 Delicate
 - 2 Spinning
 - 6 Hospitals and care-homes
 - 4 Self-service

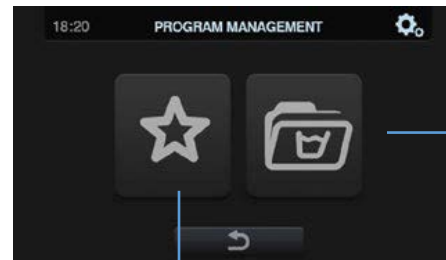

My favourite programs

Programs library

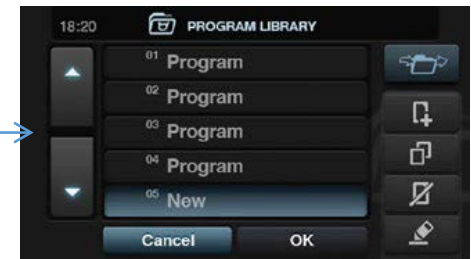

- Possibility of programming, exporting, importing (**USB**) new programs



3. MAIN FEATURES - EASY TOUCH

PROGRAMMING

- **Coin mode:** a price can be assigned to each program.
- **Easy management** of different **pricing plans**. Flexibility: Schedule your prices by hours, days, months, ...

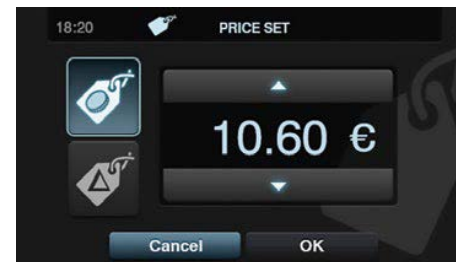

CENTRAL PAY : Ready to work with any central pay, which is external to the washer extractor.



ELECTRONIC COIN-TOKEN BOX : This device can work both with tokens or coins (all types of coins).



PREPAID CARD: Prepared to work with prepay card systems.

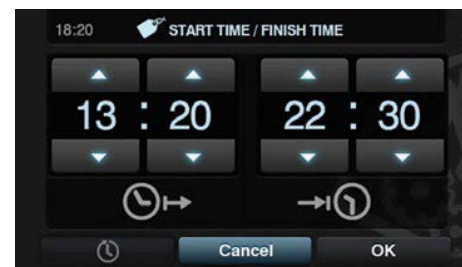

3. MAIN FEATURES - **EASY TOUCH**

FLEXIBILITY

- **8 signals** for automatic liquid dosing, programmable in time and delay.
- **Configuration of washing and spinning speed.**
- Complete **regulation of water levels.**
- **Standard WET CLEANING system.**
- Main screen display and washing process screen can be modified with parameters and images suiting each client.
- **LOADING AID** feature with water and rotation control for easy loading of the linen.



3. MAIN FEATURES - **EASY TOUCH**

ENERGY EFFICIENCY

- **4 Economic programs.**
- **REST mode**, with automatic switch off.
- **Water recovery system**, with double drain option. Water savings up to 70%.
- **OPTIMAL CONSUMPTION** standard. Manual indication of the load.

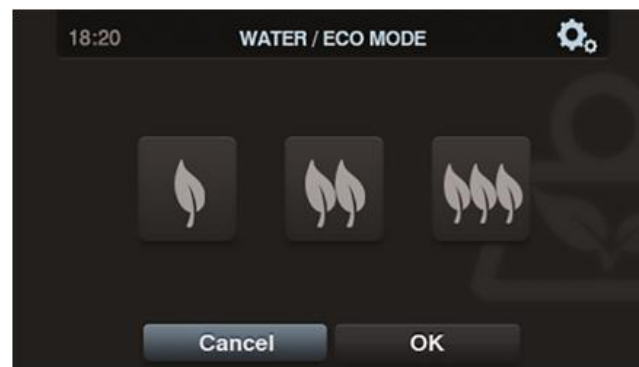

3. MAIN FEATURES - EASY TOUCH

TRACEABILITY

- All washing process (Temperatures, water levels) is stored in the washer and can be downloaded from USB port.

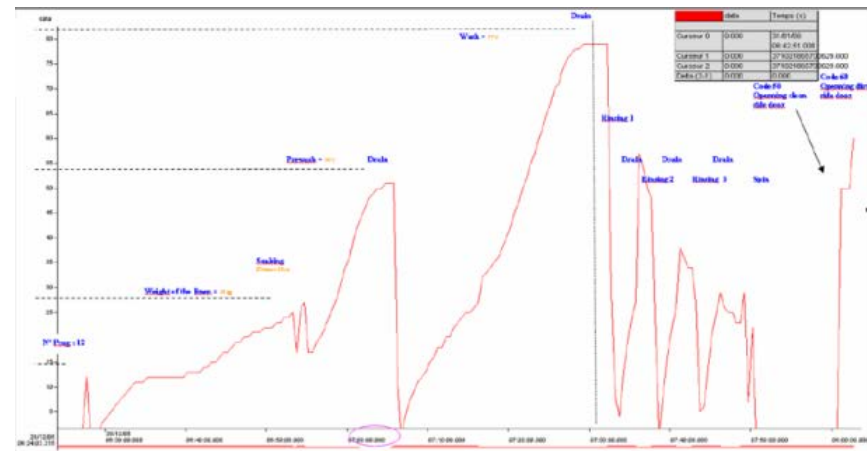
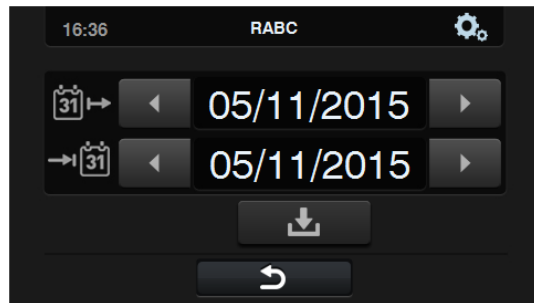

4. ACCESSORIES AND OPTIONS

Options for WED models, WEM models & WEN models

- Double drain kit allow the recovery of the water, with important savings.
- Drain pump kit (11 and 14 Kg).
- Ship Voltage (440-480/III/50-60 Hz/no neutral)
- 6 extra signals for liquid dosing.

Options for WED models

- Feet (for models 11 to 35).
- 
- Plinths for 11, 14, 18 and 25 Kg. models (Same level of the loading door=850 mm).
 - Plinths for 11, 14, 18 and 25 Kg. models (Same “washer+plinth” height for all).
 - Bottom cover for 45, 60 and 120kg washers.

4. ACCESSORIES AND OPTIONS

Options for WED models

- **Automatic weighing system.**

Efficiency: **Up to 30% savings.**

Automatic adjustment of water and soap consumptions as well as energy savings, according to the load which is measured by the washer.

- **6 extra signals for liquid dosing.**
- Double heating electric-steam kit (for electric heated models WED-45 and WED-60)
- Tilting System* – both forwards and backwards for an easy loading/unloading in WED-60 and WED-120 models.

**Weighing system is not compatible with tilting system*



Pesage



4. ACCESSORIES AND OPTIONS

Options for fast spin WEM models & normal spin WEN models

- Double drain kit allow the recovery of the water, with important savings.
- Drain pump kit (11 and 14 kg).
- Anchorage base.
- Ship Voltage (440-480/III/50-60 Hz/no neutral)
- 6 extra signals for liquid dosing.

Options for normal spin WEN models

- 8 mm diameter holes drum.
- Double heating electric-steam kit (model WEN-60 Electric)

5. TECHNICAL DATA – WED Models

DRUM	WED-11	WED-14	WED-18	WED-27	WED-36	WED-45	WED-60	WED-120
Load capacity 1:9 (kg)	11	14	20	28	39	50	67	133
Load capacity 1:10 (kg)	10	13	18	25	35	45	60	120
Volume (liters)	100	130	180	250	350	450	600	1200
Diameter (mm)	532	620	700	770	860	918	1048	1360
Depth (mm)	425	430	470	530	602	720	684	840
DIMENSIONS								
Width (mm)	692	788	884	979	1095	1428	1428	1780
Depth (mm)	788	869	913	1041	1184	1428	1428	1715
Height (mm)	1158	1307	1415	1553	1598	1910	1910	2240
Net weight (Kg)	212	254	348	502	762	1350	1400	3950
DOOR								
Height center door (mm)	625	700	750	865	885	1118	1118	1330
Height base door (mm)	408	427	490	610	522	756	756	900
Diameter (mm)	290	373	373	373	560	560	560	700
POWER								
Motor (Kw)	0,75	1,5	2,2	3	4	7,5	11	15
Heating (Kw) (Electric model)	6	9	12	18	21	28,8	36	NO
Max. power (Kw) (Electric model)	6,25	9,5	12,75	19	22	31,3	40	NO
Max. power (Kw) (Steam / hot water model)	0,75	1,5	2,2	3	4	7,5	11	15
CONNECTIONS								
Water inlet	3/4"	3/4"	3/4"	3/4"	3/4"	1"	1"	1-1/2"
Steam inlet	1/2"	1/2"	1/2"	3/4"	3/4"	3/4"	3/4"	1-1/4"
Drain (mm)	3"	3"	3"	3"	3"	3"	3"	4"
GENERAL DETAILS								
Washing speed (r.p.m)	50	50	47	45	42,5	42,5	38	34
Spining speed (r.p.m)	1245	1150	1080	1035	975	850	760	680
"G" Factor	450	450	450	450	450	350	350	350
Double drainage	NO	OPT	OPT	OPT	OPT	OPT	OPT	OPT
Weighing System	OPT	OPT	OPT	OPT	OPT	OPT	OPT	OPT
Tilting System	NO	NO	NO	NO	NO	NO	OPT	OPT

5. TECHNICAL DATA – WEM models

DRUM	WEM-11	WEM-14	WEM-18	WEM-27
Load capacity 1:9 (kg)	11	14	20	28
Load capacity 1:10 (kg)	10	13	18	25
Volume (liters)	100	130	180	250
Diameter (mm)	620	620	620	700
Depth (mm)	330	430	600	670
DIMENSIONS				
Width (mm)	719	719	788	884
Depth (mm)	697	842	851	1011
Height (mm)	1158	1158	1307	1307
Net weight (Kg)	212	241	282	404
DOOR				
Height center door (mm)	570	570	655	700
Height base door (mm)	310	310	395	440
Diameter (mm)	373	373	373	373
POWER				
Motor (Kw)	0,75	1,5	2,2	3
Heating (Kw) (Electric model)	6	9	12	18
Max. power (Kw) (Electric model)	6,25	9,5	12,75	19
Max. power (Kw) (Steam / Hot water model)	0,75	1,5	2,2	3
CONNECTIONS				
Water inlet	3/4"	3/4"	3/4"	3/4"
Steam inlet	1/2"	1/2"	1/2"	3/4"
Drain (mm)	3"	3"	3"	3"
GENERAL DETAILS				
Washing speed (r.p.m)	50	50	50	47
Spining speed (r.p.m)	760	760	760	690
"G" Factor	200	200	200	200
Double drainage	NO	NO	OPT	OPT

5. TECHNICAL DATA – WEN models

DRUM	WEN-11	WEN-14	WEN-18	WEN-27	WEN-36	WEN-60
Load capacity 1:9 (kg)	11	14	20	28	39	67
Load capacity 1:10 (kg)	10	13	18	25	35	60
Volume (liters)	100	130	180	250	350	600
Diameter (mm)	620	620	700	770	860	1048
Depth (mm)	330	430	470	530	602	684
8 mm diameter holes drum	OPT.	OPT.	OPT.	OPT.	OPT.	OPT.
DIMENSIONS						
Width (mm)	719	719	788	884	979	1225
Depth (mm)	697	842	851	965	1066	1280
Height (mm)	1158	1158	1307	1307	1411	1640
Net weight (Kg)	197	235	268	360	468	782
DOOR						
Height center door (mm)	570	570	655	700	730	900
Height base door (mm)	310	310	395	440	366	540
Diameter (mm)	373	373	373	373	560	560
POWER						
Motor (Kw)	0,75	1	1,5	2,2	3	5,5
Heating (Kw) (Electric model)	6	9	12	18	21	28,8
Max. power (Kw) (Electric model)	6,25	9,3	12,5	18,75	22	31,3
Max. power (Kw) (Hot wate / steam model)	0,75	1	1,5	2,2	3	7,5
CONNECTIONS						
Water inlet	3/4"	3/4"	3/4"	3/4"	3/4"	3/4"
Steam inlet	1/2"	1/2"	1/2"	3/4"	3/4"	3/4"
Drain (mm)	3"	3"	3"	3"	3"	3"
GENERAL DETAILS						
Washing speed (r.p.m)	53	53	50	48	45	42,5
Spining speed (r.p.m)	536	536	505	481	455	415
"G" Factor	100	100	100	100	100	100
Double drainage	NO	NO	OPT.	OPT.	OPT.	OPT.

6. SALES ARGUMENTS

SMALL-MEDIUM CAPACITY WED WASHERS	DANUBE	GIRBAU	ALLIANCE	ELECTROLUX
Stainless steel external panels	Std.	\$ Opt	\$ Opt	\$ Opt
3rd water inlet	Std.	\$ Opt Inteli	\$ Opt	\$ Opt
Wet-Cleaning	Std.	Std.	-	\$ Opt
Traceability	Std.	-	\$ Opt	\$ Opt
Weighing system	\$ Opt	\$ OptHS6023	\$ Opt Mod.18 a 23	\$ Opt
Touch control	Std.	No	No	No

HIGH CAPACITY WED WASHERS	DANUBE	GIRBAU	ALLIANCE	ELECTROLUX
Stainless steel external panels	Std.	\$ Opt.	Std.	Std.
3rd water inlet	Std.	\$ Opt.	Std.	\$ Opt
Wet-Cleaning	Std.	Std.	-	\$ Opt.
Traceability	Std.	-	\$ Opt.	\$ Opt
Weighing system	\$ Opt.	\$ Opt.	\$ Opt.	\$ Opt
Touch control	Std.	No	No	No

SMALL-MEDIUM CAPACITY WEM / WEN WASHERS	DANUBE	GIRBAU	ALLIANCE	ELECTROLUX
Stainless steel external panels	Std.	\$ Opt.	\$ Opt.	\$ Opt.
3rd water inlet	Std.	No	\$ Opt.	\$ Opt.
Wet-Cleaning	Std.	No	-	\$ Opt.
Traceability	Std.	No	\$ Opt.	No
Touch control	Std.	No	No	No

6.1 SALES ARGUMENTS VS. COMPETITORS

“WED” Washer models **G-FACTOR 450**

- High Spin washers from WED-11 to 35
- Highest G-Factor in the Market
- Reduced linen water retention

BRAND	MODEL	Kg (1/9)	Kg (1/10)	Volume (liters)	Spinning speed (r.p.m.)	"G-Factor"
DANUBE	WED-11	11	10	100	1245	450
PRIMUS-Alliance	FX-105	11,5	10,5	105,6	1075	400
ELECTROLUX	W5105H	11,5	10,5	105	1165	450
IMESA	LM-11	12	11	105	1002	300
SCHULTHESS	WEI 9100	11	10	100	1100	375
DANUBE	WED-14	14,5	13	130	1150	450
GIRBAU	HS-6013	14	13	126	1005	351
PRIMUS-Alliance	FX-135	15	14	135	1075	400
ELECTROLUX	W5130H	14	13	130	1115	450
IMESA	LM-14	15,5	14	140	900	316
SCHULTHESS	WEI 9130	14	13	130	1100	419
DANUBE	WED-18	20	18	180	1080	450
GIRBAU	HS-6017	19	17	173	950	354
PRIMUS-Alliance	FX-180	20	18	180	980	400
ELECTROLUX	W5180H	20	18	180	1055	450
IMESA	LM-18	20	18	180	900	316
SCHULTHESS	WSI-200	22	20	200	1000	442

BRAND	MODEL	Kg (1/9)	Kg (1/10)	Volume (liters)	Spinning speed (r.p.m.)	"G-Factor"
DANUBE	WED-27	28	25	250	1035	450
GIRBAU	HS-6023	25	23	228	920	351
PRIMUS-Alliance	FX-240	27	24	240	980	400
ELECTROLUX	W5240H	27	24	240	1005	450
IMESA	LM-23	25	23	215	900	316
SCHULTHESS	WSI-250	28	25	250	950	403
DANUBE	WED-36	39	35	350	975	450
ELECTROLUX	W5300H	33	30	300	950	400
PRIMUS-Alliance	FS-33	36	33	330	830	350
IMESA	LM-30	35	32	318	900	316

6.1 SALES ARGUMENTS VS. COMPETITORS

- **Competitive price level, with standard features**, which are far superior to its competitors:
 - Stainless steel body
 - G-Factor 450 (models WED-11 to 35)
 - 3rd water inlet
 - Traceability
 - All models are programmable
- **Versatility:** Models (OPL-COIN), different types of heating and voltages, installable kits and accessories
- **New 35 kg model**, very competitive (price-performance-size)
- **New Easy Touch Control**, high level of performance, ...
- **Reduced water consumption** (control of water recovery tanks, optimal consumption, weighing system...)

6.2 MAIN FEATURES - Pictograms



Eau chaude
et Eau froide



3 arrivées d'eau



Inverter



Tambour efficace



Wet cleaning



Charge optimale



Inox



Pesage

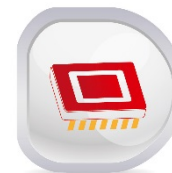

Programmateur
électronique



Recyclage 95%

6.3 COMPARISON AMONG DIFFERENT TYPES OF WASHER EXTRACTORS

TYPE OF WASHER EXTRACTOR	"G" FACTOR	TYPE OF INSTALLATION	MOISTURE RETENTION		TIME OF DRYING	TOTAL COSTS DURING FIRST TWO YEARS			
			100% COTTOM	50% COTTOM 50% POLYESTER					
HIGH SPIN WASHERS	350-450	Soft-Mounted	55%	45%	30'	2,1	38,4	74,5	
FAST SPIN WASHERS	200	Hard-Mounted	70%	60%	40'	21	6,5	51	78,5
LOW SPIN WASHERS	100	Hard-Mounted	100%	90%	60'	17	6,5	76,5	100

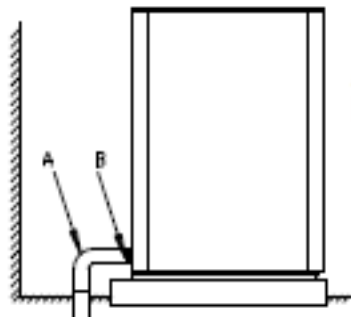

A= Drainage pipe bend
B=Clamp

Rear space needed:

- Minimum: 50 cm
- Recomended 80 cm

WED models are not need to be anchored to the floor, but it's recommendable

4 anchors for fixing the washer (Required in WEM /WEN Models)

Important : level floor

